



2/2-way-Angle-Seat Control Valve, Threaded port and weld end, Port size DN 15-50

- Excellent control characteristic and high flow rates
- Durable, robust and cost effective
- Ultra compact design, low weight
- Quality certifications available

Type 2702 can be combined with...



Type 8692/8693
Positioner / Prozess
controller TopControl



Type 8694
Positioner
TopControl Basic



Type 8630
Positioner
TopControl



Type 8635
Positioner Side-
Control



Type 8792/93
SideControl Remote-
Versions



Type 8030
Flow sensor

The 2702 Control Valve consists of an 316L angle seat body with a rugged pneumatic piston actuator. The parabolic trim results in a flow characteristic approximately 35% larger than conventional control valves. It is available in either stainless steel on stainless steel or with a durable PTFE seal for tight shut-off.

Type 2702 can be actuated by the Continuous TopControl Type 8692/8693/8694/8630 or SideControl Type 8635 and 8792/93. TopControl/SideControl thus forms a mechanical and functional unit with the pneumatic actuator as a complete control valve system.

This system has been engineered for reliable accurate control in applications where high flow rate is an advantage.

Proven Applications

- Food and beverage CIP/SIP and auxiliary processes with steam, chilled water and glycol
- Textile machinery (steam, water, air) and dyeing
- Heat exchangers and autoclaves
- Sterilizers and washers
- Distillation apparatus
- Packaging and filling machinery

Technical data

Material	Body Actuator	Cast stainless steel (conform to 1.4409) PA polyamide (PPS on request)
Seat sealing		St.st./St.st. (stainless steel/stainless steel), PTFE/St.st. (PTFE/stainless steel)
Seat leakage according to IEC 534-4/EN 1349		Shut-off class IV for St.st./St.st. Shut-off class VI for PTFE/St.st.
Process media (vacuum version on request)		For neutral gases, water, alcohols, oils, fuels, hydraulic liquids, salt solutions, lyes, organic solvents, steam (10 bar(abs)/+180°C)
Viscosity		max. 600 mm ² /s
Spindle packing		PTFE-Seal (with silicone grease) with spring compensation
Nominal pressure		PN 25 (body)
Temperatures	Medium Ambient	-10°C to +180°C ¹⁾ (max. +130°C for PTFE/St.st. sealing recommended) -10°C to +60°C ¹⁾
Control medium		Instrument air
Control pressure		5.5 to 7 bar
Pilot air ports:		G 1/4 stainless steel (St. st.)
Flow direction		Below seat
Flow characteristics		Modified equal percentage
Control ratio (Kvs/KvO)		More than 50:1

1) high temperature on request

continued on next page

Content

Valve specifications		System Continuous Classic		Request for quotation
Type 2702		Type 8802-YC		Type 8802-YC
Technical data & ordering info.	p. 1-7	Ordering info. & technical data	p. 8-12	p. 13



Technical data, continued

Technical data		
Port connections	Threaded	
	G	<ul style="list-style-type: none"> ▪ DIN ISO 228 ▪ ANSI/ASME B1.20.1 ▪ ISO 7
	NPT Rc	<ul style="list-style-type: none"> ▪ EN ISO 1127/ISO 4200
Weld end	ISO	<ul style="list-style-type: none"> ▪ DIN 11850 series 2
	DIN	<ul style="list-style-type: none"> ▪ SMS 3008 (on request)
	SMS	<ul style="list-style-type: none"> ▪ BS 4825 part 1 (on request)
	OD-Tube	<ul style="list-style-type: none"> ▪ ASME BPE (on request)
Installation		As required, preferably with actuator in upright position

Flow characteristic

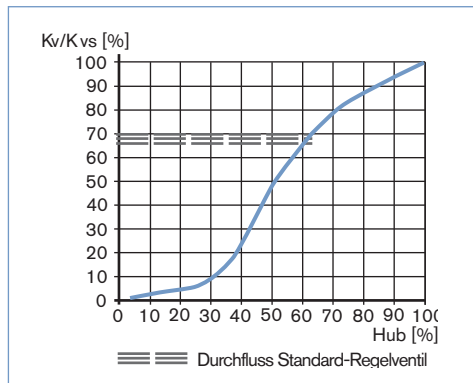

Remarks on the flow characteristic

Modified equipercentile flow characteristic, engineered for a quick response during peak flow demand (an advantage for many processes like heating/cooling with heat exchangers) and fine control at lower flow.

Kvs values [m³/h]

Port size [mm]	Actuator size [mm]	Stroke [%]										
		5	10	20	30	40	50	60	70	80	90	100
15	80	0,23	0,24	0,26	0,35	0,7	1,85	2,9	3,5	4	4,3	4,5
20	80	0,30	0,33	0,42	0,7	2,85	5,3	6,6	7,5	8,2	8,6	9
25	80	0,39	0,41	0,60	1,25	4,5	8,5	10,5	12,2	13,5	14,2	15
32	80	0,55	0,65	0,95	1,5	4	9,3	13,8	16,5	18,8	21	23
40	100	0,65	0,85	1,5	5	14	20	25	27	30	33	35
50	100	1	1,3	2	5	16	27	34	41	45	49	53

Ordering chart for Angle seat valve (without positioner)

Valves with threaded port connection, flow below seat

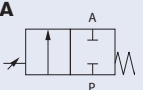
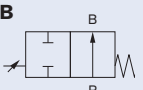
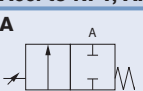
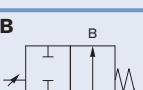
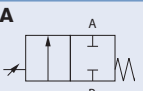
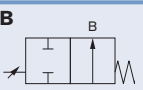
	Control function	Port size		Actuator size Ø [mm]	Kvs values [m³/h]	Operating pressure ≤ +180°C [bar]	Item no. seal system* St.st./St.st.	Item no. seal system* PTFE/St.st.
		[mm]	[Zoll]					
Acc. to G, DIN ISO 228, flow below seat								
 <p>2/2-way-valve, normally closed by spring action (NC)</p>	15	1/2"	80	4,5	16	165 523	165 486	
	20	3/4"	80	9	16	165 526	165 489	
	25	1"	80	15	16	165 531	165 513	
	32	1 1/4"	80	23	15	165 537	165 515	
	40	1 1/2"	100	35	12,5	165 540	165 518	
	50	2"	100	53	7,2	165 543	165 520	
 <p>2/2-way-valve, normally open by spring action; (NO)</p>	15	1/2"	80	4,5	16	165 580	165 546	
	20	3/4"	80	9	16	165 584	165 549	
	25	1"	80	15	16	165 566	165 553	
	32	1 1/4"	80	23	15	165 569	165 557	
	40	1 1/2"	100	35	12,5	165 592	165 572	
	50	2"	100	53	7,2	165 598	165 575	
Acc. to NPT, ANSI/ASME B1.20.1, flow below seat								
 <p>2/2-way-valve, normally closed by spring action (NC)</p>	15	1/2"	80	4,5	16	463 837	463 843	
	20	3/4"	80	9	16	463 838	463 844	
	25	1"	80	15	16	463 839	463 845	
	32	1 1/4"	80	23	15	463 840	463 846	
	40	1 1/2"	100	35	12,5	463 841	463 847	
	50	2"	100	53	7,2	462 106	462 100	
 <p>2/2-way-valve, normally open by spring action; (NO)</p>	15	1/2"	80	4,5	16	463 849	463 855	
	20	3/4"	80	9	16	463 850	463 856	
	25	1"	80	15	16	463 851	463 857	
	32	1 1/4"	80	23	15	463 852	463 858	
	40	1 1/2"	100	35	12,5	463 853	463 859	
	50	2"	100	53	7,2	462 123	462 114	
Acc. to Rc, ISO 7, flow below seat								
 <p>2/2-way-valve, normally closed by spring action (NC)</p>	15	1/2"	80	4,5	16	507 413	507 419	
	20	3/4"	80	9	16	507 414	507 420	
	25	1"	80	15	16	507 415	507 421	
	32	1 1/4"	80	23	15	507 416	507 422	
	40	1 1/2"	100	35	12,5	507 417	507 423	
	50	2"	100	53	7,2	507 152	507 146	
 <p>2/2-way-valve, normally open by spring action; (NO)</p>	15	1/2"	80	4,5	16	507 425	507 431	
	20	3/4"	80	9	16	507 426	507 432	
	25	1"	80	15	16	507 427	507 433	
	32	1 1/4"	80	23	15	507 428	507 434	
	40	1 1/2"	100	35	12,5	507 429	507 435	
	50	2"	100	53	7,2	507 158	507 164	

*seal system:

- St. st./St. st.: plug stainless steel/seat stainless steel
- PTFE/St.st.: (soft sealing) plug PTFE/seat stainless steel

 Weitere Ausführungen auf Anfrage

 **Materials**
Actuator: PPS

 **Media temperature**
Valves for medium temperature to +200°C or to -40°C

Ordering chart for Angle seat valve (without positioner), continued

Valves with threaded port connection, flow below seat

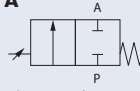
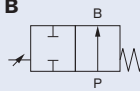
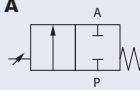
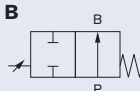
	Control function	Port size		Dimensions Ø Pipe x wall thickness [mm]	Actuator size Ø [mm]	Kvs values [m³/h]	Operating pressure S +180°C [bar]	Item no. seal system* St.st./St.st.	Item no. seal system* PTFE/St.st.
		[mm]	[Zoll]						
Acc. EN ISO 1127/ISO 4200, flow below seat									
 2/2-way-valve, normally closed by spring action (NC)	15	1/2"	21.3 x 1.6	80	4,5	16	165 524	165 487	
	20	3/4"	26.9 x 1.6	80	9	16	165 529	165 511	
	25	1"	33.7 x 2.0	80	15	16	165 534	165 514	
	32	1 1/4"	42.4 x 2.0	80	23	15	165 538	165 516	
	40	1 1/2"	48.3 x 2.0	100	35	12,5	165 541	165 519	
	50	2"	60.3 x 2.0	100	53	7,2	165 544	165 521	
 2/2-way-valve, normally open by spring action; (NO)	15	1/2"	21.3 x 1.6	80	4,5	16	165 582	165 547	
	20	3/4"	26.9 x 1.6	80	9	16	165 585	165 551	
	25	1"	33.7 x 2.0	80	15	16	165 567	165 554	
	32	1 1/4"	42.4 x 2.0	80	23	15	165 570	165 559	
	40	1 1/2"	48.3 x 2.0	100	35	12,5	165 596	165 573	
	50	2"	60.3 x 2.0	100	53	7,2	165 599	165 578	
Acc. DIN 11850 series 2, flow below seat									
 2/2-way-valve, normally closed by spring action (NC)	15	1/2"	19.0 x 1.5	80	4,5	16	165 525	165 488	
	20	3/4"	23.0 x 1.5	80	9	16	165 530	165 512	
	25	1"	29.0 x 1.5	80	15	16	165 536	165 030	
	32	1 1/4"	35.0 x 1.5	80	23	15	165 539	165 517	
	40	1 1/2"	41.0 x 1.5	100	35	12,5	165 542	164 778	
	50	2"	53.0 x 1.5	100	53	7,2	165 545	165 522	
 2/2-way-valve, normally open by spring action; (NO)	15	1/2"	19.0 x 1.5	80	4,5	16	165 583	165 548	
	20	3/4"	23.0 x 1.5	80	9	16	165 586	165 552	
	25	1"	29.0 x 1.5	80	15	16	165 568	165 556	
	32	1 1/4"	35.0 x 1.5	80	23	15	165 591	165 571	
	40	1 1/2"	41.0 x 1.5	100	35	12,5	165 597	165 574	
	50	2"	53.0 x 1.5	100	53	7,2	165 600	165 579	

*seal system:

- St. st./St. st.: plug stainless steel/seat stainless steel
- PTFE/St.st.: (soft sealing) plug PTFE/seat stainless steel

i Weitere Ausführungen auf Anfrage**Materials**

Actuator: PPS

**Port connections**

SMS 3008, BS 4825 part 1, ASME BPE

**Media temperature**

Valves for medium temperature to +200°C or to -40°C

Materials

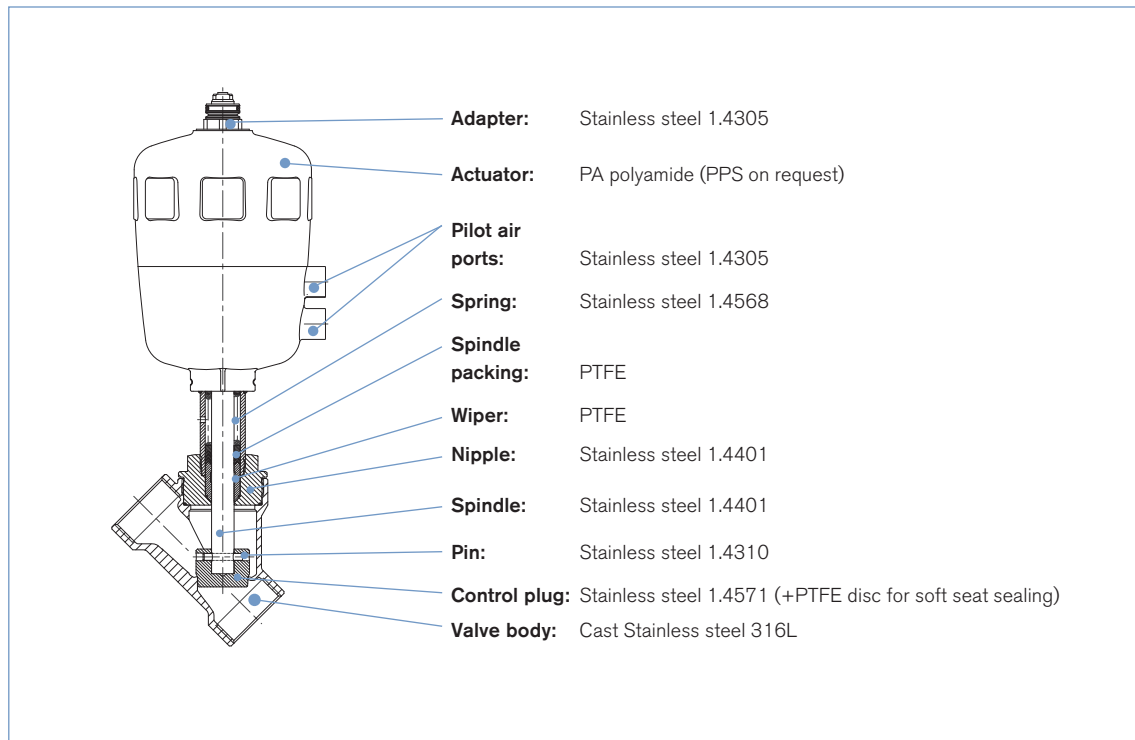

Spare parts for Type 2702 – DN 15-50 (on request)

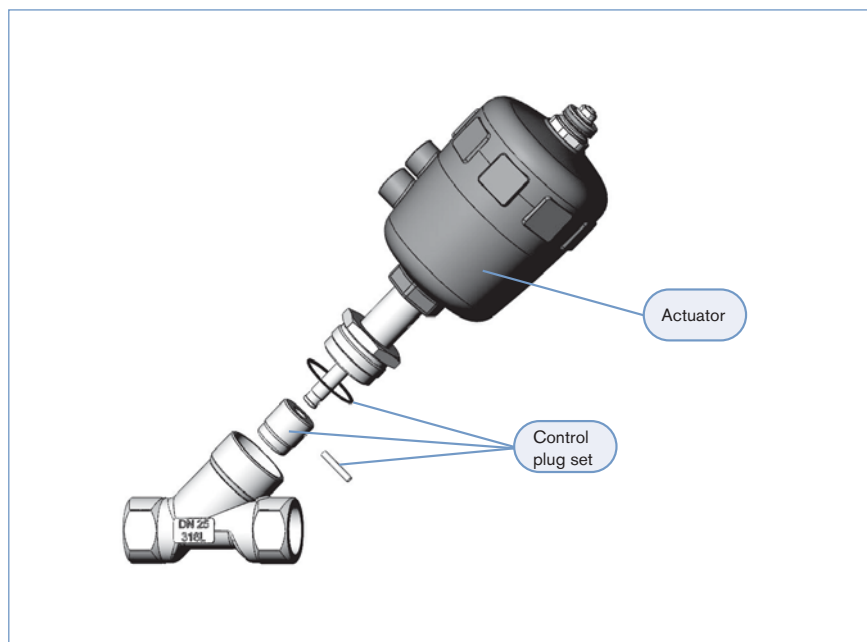

Dimensions Angle seat valve [mm]

Angle seat valve with threaded and weld end connection

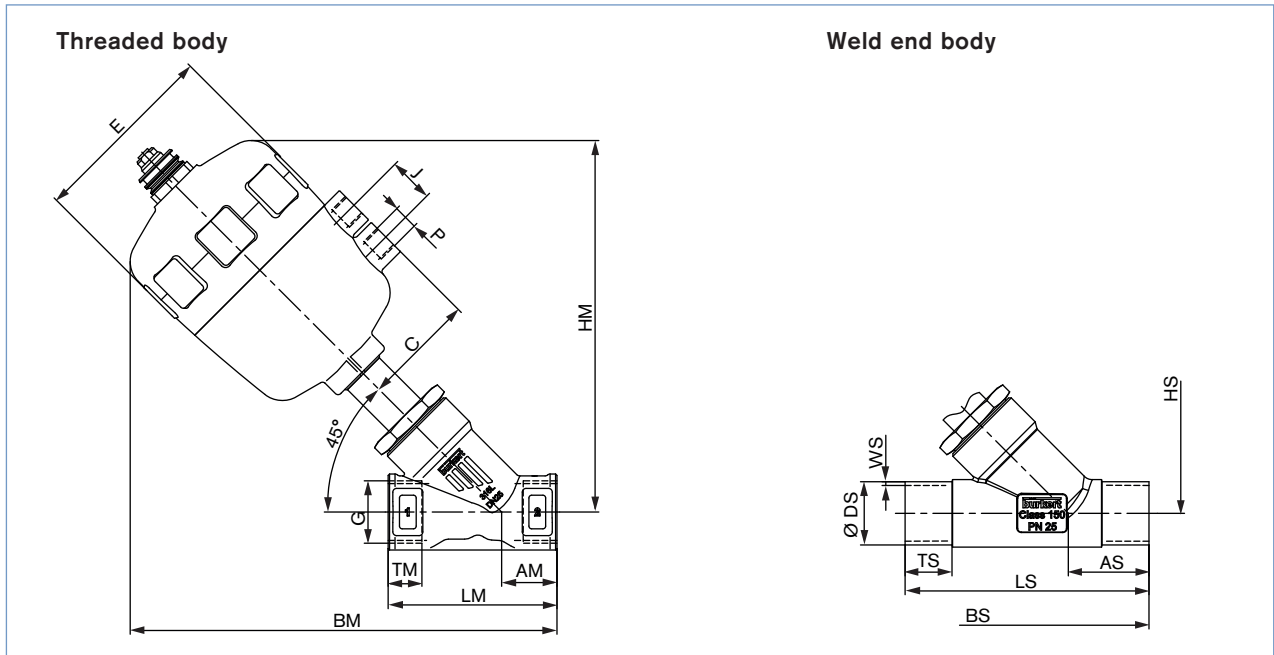

All actuators

Port size [mm]	Actuator size Ø [mm]	ØE	C	P	J
15	80	101	60	G 1/4	24
20	80	101	60	G 1/4	24
25	80	101	60	G 1/4	24
32	80	101	60	G 1/4	24
40	100	127	73	G 1/4	30
50	100	127	73	G 1/4	30

Threaded ports

All threaded bodies		G, NPT and Rc thread				TM		
DN [mm]	HM	BM	LM	AM	G	G thread	NPT thread	RC thread
15	185	209	65	24	G 1/2	14	13,7	13,2
20	193	220	75	27	G 3/4	16	14,0	14,5
25	198	228	90	29,5	G 1	18	16,8	16,8
32	206	242	110	36	G 1 1/4	16	17,3	19,1
40	261	296	120	35	G 1 1/2	18	17,3	19,1
50	275	320	150	45	G 2	24	17,6	23,4

Weld end ports

All welded DN [mm]	EN ISO 1127/ISO 4200 and DIN 11850 Series 2										BS 4825 P1, ASME BPE, SMS 3008										
	HS	EN ISO 1127/ISO 4200				DIN 11850 R2			DN [Zoll]	BS 4825 P1, ASME BPE				SMS 3008							
		BS	LS	AS	ØDS	TS	WS	ØDS		TS	WS ¹⁾	WS ²⁾	ØDS	TS	WS						
15	198	232	100	34	21,3	20	1,6	19	20	1,5	1/2"	244	135	46	12,7	38	1,2	1,65	12	38	1
20	198	237	115	39	26,9	25	1,6	23	20	1,5	3/4"	250	145	52	19,05	38	1,2	1,65	18	38	1
25	199	242	130	43	33,7	30	2	29	26	1,5	1"	250	152	51	25,4	38	1,65	1,65	25	38	1,2
32	209	244	145	40	42,4	26	2	35	26	1,5	-	-	-	-	-	-	-	-	-	-	-
40	263	312	160	49	48,3	30	2	41	26	1,5	1 1/2"	323	182	60	38,1	38	1,65	1,65	38	38	1,2
50	277	327	175	50	60,3	30	2,6	53	26	1,5	2"	341	210	64	50,8	45	1,65	1,65	51	45	1,2

¹⁾ BS 4825 P1 ²⁾ ASME BPE

Ordering information for valve system Continuous Classic Type 8802-YC

A valve system Continuous Classic Typ 8802-YC consists of an angle-seat control valve Type 2702 and a digital electropneumatic positioner Type 8692, a digital electropneumatic process controller Type 8693, a digital electropneumatic positioner Basic Type 8694 or an electropneumatic positioner Type 8630 (below), a SideControl Type 8635 or an electropneumatic positioner Type 8792/8793 (next page) (see separate datasheets). For the configuration of further valve systems please use the "Request for quotation" on p. 13 [go to page](#)

You order two components and receive a complete assembled and certified valve.

Ordering the valve system Continuous Classic Type 8802-YC

Angle-seat control valve Type 2702



Positioner



Positioner
Type 8692



Process Controller
Type 8693



Positioner Basic
Type 8694

Angle-seat control valve with desired control unit



Valve system
Continuous Classic
Type 8802-YC-I
2702 + 8692



Valve system
Continuous Classic
Type 8802-YC-J
2702 + 8693



Valve system
Continuous Classic
Type 8802-YC-L
2702 + 8694

When you click on the orange box "More info." below, you will come to our website for the resp. product where you can download the datasheet.

Positioner TopControl Type 8692

More info.



Process Controller TopControl Type 8693

More info.



The new generation of integrated positioners/process controllers for combination with actuators from the process valve series Type 23xx/2103 is specially designed for the requirements of hygienic process environments. The easy handling and the selection of additional software functions are done either on a big graphic display with backlight and keypad or via a PC interface. A contact-free analogue position sensor registers the valve position without deterioration. Single-acting or double-acting actuators are controlled via the integral positioner system. With Type 8693, the process controller function is superimposed on the position control loop. Profibus DPV1 and DeviceNet communication interfaces are available as options.

Main customer benefits:

- Compact design of the valve system with integrated positioner/process controller meets the demands for plant washdown environments through the selection of materials, external seals and integrated control air supply to the actuator
- Extremely simple commissioning and operation thanks to the backlighting of the graphics display and proven multilingual software structure
- Automatic parameterisation of the positioner and process controller using the TUNE functions
- Field bus communication via Profibus DPV1 or DeviceNet
- Air intake filter enhances the process valve system availability
- Simple and reliable actuator adaption
- Explosion-proof models for zone 2/22

Positioner TopControl Basic Type 8694

More info.



The new generation of integrated positioners for combination with actuators from the process valve series Type 23xx/2103 is specially designed for the requirements of hygienic process environments. The operation and selection of the software functions close tight function, inversion of the operating direction of the setpoint signal, characteristic curves selection and switching manual/automatic operation are effected via push-buttons and DIP switches or via the PC interface. The position setpoint is set using the standard signal 4–20 mA. In addition, the enable can be controlled via the binary input and an optional position feedback can be integrated. The positioner, Type 8694, registers the valve position without deterioration through a contact-free analogue position sensor. Single-acting or double-acting actuators are controlled via the integral positioner system. An AS-Interface communication interface is available as an option.

Main customer benefits:

- Compact design of the valve system with integrated positioner meets the demands for plant washdown environments through the selection of materials, external seals and integrated control air supply to the actuator
- Automatic parameterisation of the process controller using the Process TUNE function
- Field bus communication via optional AS-Interface
- Air intake filter enhances the process valve system availability
- Simple and reliable actuator adaption allowing additional actuators of the process valve series, Type 20xx or actuators from other manufacturers to be used
- Explosion-proof models for zone 2/22

Ordering information for valve system Continuous Classic Type 8802-YC

A valve system Continuous Classic Type 8802-YC consists of an angle-seat control valve Type 2702 and a digital electropneumatic positioner Type 8692, a digital electropneumatic process controller Type 8693, a digital electropneumatic positioner Basic Type 8694 (previous page) or an electropneumatic positioner Type 8630, a SideControl Type 8635 or an electropneumatic positioner Type 8792/8793 (below) (see separate data-sheets). For the configuration of further valve systems please use the "Request for quotation" on p. 13 [go to page](#)

You order two components and receive a complete assembled and certified valve.

Ordering the valve system Continuous Classic Type 8802-YC

Angle-seat control valve
Type 2702

Positioner



Positioner/
Process Controller
Type 8630



Positioner/
Process Controller
Type 8635



Positioner
Type 8792/
Process
Controller
Type 8793



Valve system
Continuous Classic
Type 8802-YC-A
2702 + 8630



Valve system
Continuous Classic
Type 8802-YC-B
2702 + 8635



Valve system
Continuous Classic
Type 8802-YC-P
2702 + 8792 /
Type 8802-YC-Q
2702 + 8793

When you click on the orange box "More info." below, you will come to our website for the resp. product where you can download the datasheet.

TopControl Type 8630

More info.



0/4-20 mA
0-5/10 V

PROFIBUS DeviceNet



The Type 8630 is an electro-pneumatic positioner for usage with pneumatically operated process valves. The compact design with integrated position encoder and LCD display was developed for demanding applications of the process industry.

Main customer benefits are:

- Time saving algorithms for temperature, flow and pressure PID parameters through ProcessTUNE function.
- Quick and simple menu driven parameterization through keyboard
- Field bus communication via Profibus DPV1 or DeviceNet
- Fits seamlessly to Bürkert's process valve systems
- Break resistant housing
- Explosion proofed versions for zone 2/22

SideControl Type 8635, 2-wire, intrinsically safe

More info.



4-20 mA

PROFIBUS



Type 8635 is a digital electropneumatic positioner with an optional, integrated process controller for precise control requirements. The compact design with integrated LCD display was developed for demanding applications of the process industry.

Main customer benefits:

- Time saving algorithms for temperature, flow and pressure PID parameters through ProcessTUNE function.
- Quick and simple menu driven parameterization through keyboard or Profibus PA
- Remote setpoint adjustment via a 4-20 mA signal
- Adaptation according to IEC534-6 for lift and swivel drives
- Rugged anodised aluminium housing
- Suitable for hazardous locations per zone 1, zone 21 or zone 2 and 22

Positioner SideControl Type 8792
Process Controller SideControl Type 8793

More info.

More info.



PROFIBUS



Type 8792/8793 is a digital electro-pneumatic positioner with an optional, integrated process controller (8793) for precise control requirements. Das robuste Design mit integriertem LCD Klartextdisplay wurde für anspruchsvolle Anwendungen der Verfahrenstechnischen Industrie entwickelt. A Profibus DPV1 communication interface is available as an option.

Main customer benefits:

- Time saving algorithms for temperature, flow and pressure PID parameters through ProcessTUNE function.
- Quick and simple menu driven parameterization through keyboard or Profibus DPV1 PA
- Adaption acc. to IEC534-6 and VDI/VDE 3845 for lift and swivel drives or as a Remote version together with Bürkert process valves
- Rugged anodised aluminium housing
- Explosion proofed versions for zone 2/22

Dimensions for valve system Continuous Classic Type 8802-YC [mm]

Dimensions valve system Continuous Type 8802-YC-I with positioner TopControl Type 8692 or 8802-YC-J with process controller TopControl Type 8693 [mm]

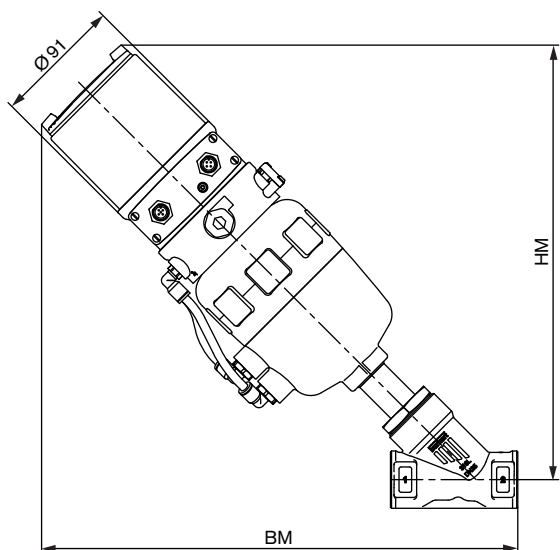

Threaded body

Port size [mm]	Actuator size [mm]	HM [mm]	BM G NPT and Rc thread
15	80	302	326
20	80	302	329
25	80	307	337
32	80	314	349
40	100	363	398
50	100	375	420

Welded body

Port size [mm]	Actuator size [mm]	HM [mm]	BM EN ISO 1127/ISO 4200, DIN 11850 S2	BS 4825, SMS 3008, ASME BPE
15	80	307	341	353
20	80	307	345	358
25	80	308	351	359
32	80	318	358	358
40	100	363	411	422
50	100	380	430	444

Further dimensions see p. 7

Dimensions for valve system Continuous Classic Type 8802-YC [mm], continued

Dimensions valve system Continuous Classic Type 8802-YC-L with positioner TopControl Basic Type 8694 [mm]

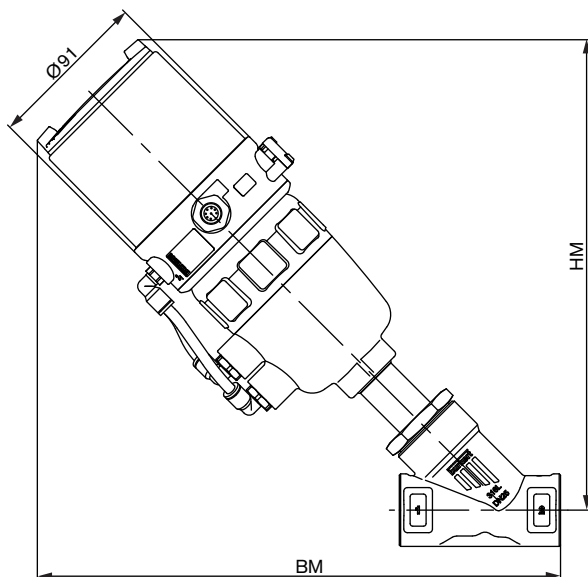

Threaded body

Port size [mm]	Actuator size [mm]	HM [mm]	BM G NPT and Rc thread
15	80	274	298
20	80	274	300
25	80	278	308
32	80	286	320
40	100	334	370
50	100	346	–

Welded body

Port size [mm]	Actuator size [mm]	HM [mm]	BM EN ISO 1127/ISO 4200, DIN 11850 S2	SMS 3008, ASME BPE, BS 4825
15	80	280	314	326
20	80	278	318	330
25	80	278	322	330
32	80	290	330	330
40	100	338	386	398
50	100	352	402	416

Further dimensions see p. 7

Dimensions for valve system Continuous Classic Type 8802-YC [mm], continued

Dimensions valve system Continuous Classic Type 8802-YC-A with positioner TopControl Type 8630 [mm]

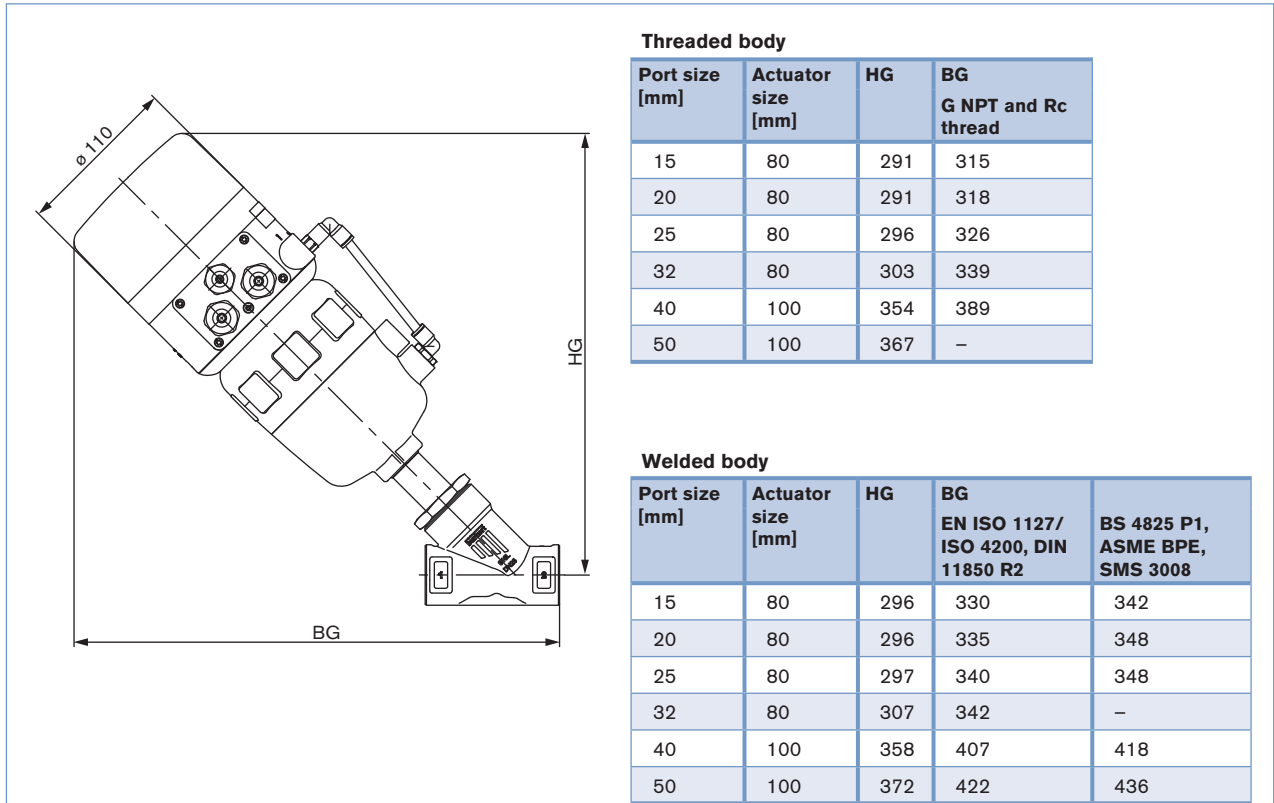

Further dimensions see p. 7

Dimensions valve system Continuous Classic 8802-YC-B with positioner SideControl Type 8635 [mm]

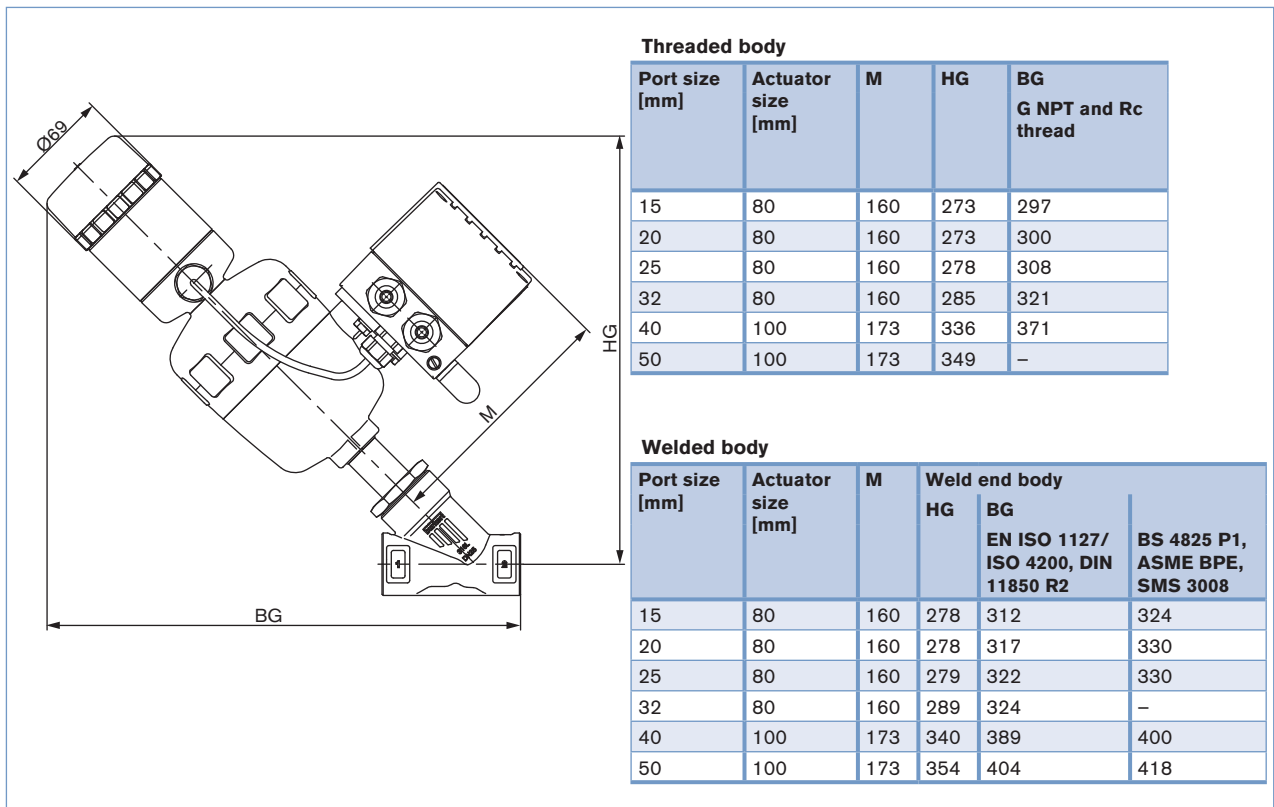

Further dimensions see p. 7

Dimensions for valve system Continuous Classic Type 8802-YC [mm], continued

Dimensions valve system Continuous Classic 8802-YC-P with Positioner SideControl Remote Type 8792 and Type 8802-YC-Q with Process Controller SideControl Remote Type 8793 [mm]

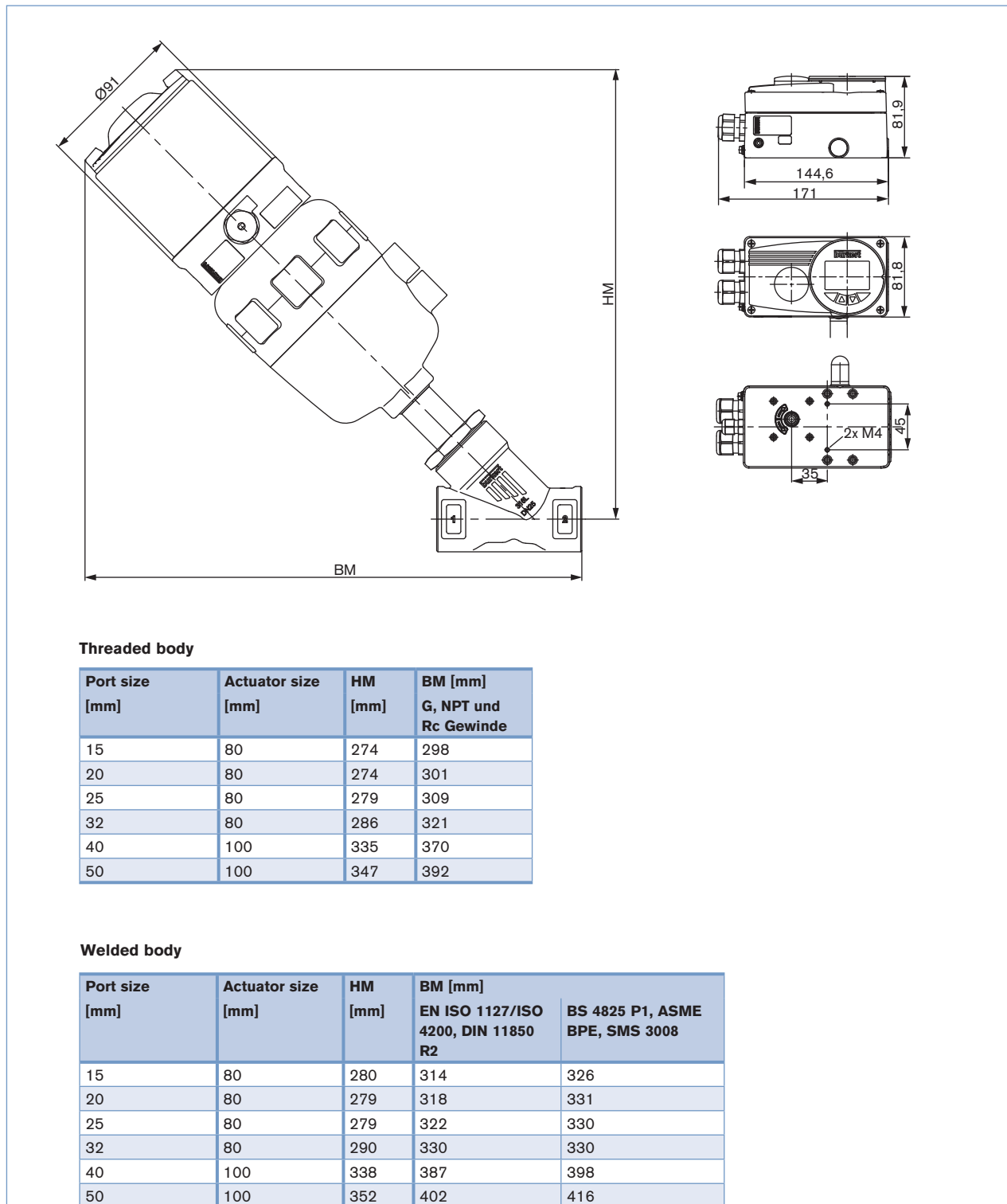

Further dimensions see p. 7

Note

You can fill out the fields directly in the PDF file before printing out the form.

Valve system Continuous Classic Type 8802-YC-B – Request for quotation

▶ Please fill out and send to your nearest Bürkert facility* with your inquiry or order

Company	Contact person
Customer No	Department
Address	Tel./Fax
Postcode/Town	E-mail

= mandatory fields to fill out Quantity Required delivery date

Operating data

Pipeline	DN	<input type="text"/>	PN	<input type="text"/>
Pipe material	<input type="text"/>			
Process medium	<input type="text"/>			
Type of medium	<input type="checkbox"/> Liquid	<input type="checkbox"/> Steam	<input type="checkbox"/> Gas	
Flow rate (Q, Q _N , W) ¹⁾	Min	Standard	Max	Unit
Temperature at valve inlet	<input type="text"/>	<input type="text"/>	<input type="text"/>	<input type="text"/>
Absolute pressure at valve outlet P2	<input type="text"/>	<input type="text"/>	<input type="text"/>	<input type="text"/>

¹⁾ standard unit: Liquid Q = m³/h; Steam W = kg/h; Gas Q_N = Nm³/h

Valve features

Actuator material	<input type="checkbox"/> PA	<input type="checkbox"/> PPS		
Body material	<input type="checkbox"/> Cast stainless steel			
Seat sealing material	<input type="checkbox"/> St. st./St. st.	<input type="checkbox"/> PTFE/St. st.		
Nominal pressure	PN	<input type="text"/>		
Orifice	DN	<input type="text"/>		
Connection	<input type="checkbox"/> Weld	<input type="checkbox"/> thread		
Connection acc. to Standard	<input type="checkbox"/> ISO	<input type="checkbox"/> DIN	<input type="checkbox"/> ANSI	<input type="checkbox"/> Other <input type="text"/>
Control function	<input type="checkbox"/> NC ²⁾	<input type="checkbox"/> NO ²⁾		
Pilot pressure	<input type="text"/> min.	<input type="text"/> max.		
Please specify item no. if known:	<input type="text"/>			

²⁾ NC: normally closed by spring action; NO: normally open by spring action

continued on next page

* To find your nearest Bürkert facility, click on the orange box



www.burkert.com

Valve system Continuous Classic Type 8802-YC - Request for quotation, Forts.

Control unit features		
<input type="checkbox"/> Positioner TopControl Type 8692 More info.	<input type="checkbox"/> Process Controller TopControl Type 8693 More info.	<input type="checkbox"/> Positioner TopControl Basic Type 8694 More info.
Pneumatic function <input type="checkbox"/> Single-acting <input type="checkbox"/> Double-acting Communication <input type="checkbox"/> Profibus <input type="checkbox"/> DeviceNet Electrical connection <input type="checkbox"/> Cable gland <input type="checkbox"/> Multipol connection Feedback <input type="checkbox"/> 4-20 mA <input type="checkbox"/> 4-20 mA + 2 binary outputs Initiator <input type="checkbox"/> Initiator Please specify item no. if known: <input type="text"/>		Pneumatic function <input type="checkbox"/> Single-acting Pilot air ports: <input type="checkbox"/> Push-in connector external ø 6 mm or 1/4" <input type="checkbox"/> Thread G 1/8" Electrical connection <input type="checkbox"/> Cable gland <input type="checkbox"/> Multipol connection Feedback <input type="checkbox"/> 4-20 mA Please specify item no. if known: <input type="text"/>
<input type="checkbox"/> Positioner TopControl Type 8630 – 3-wire More info.	<input type="checkbox"/> Positioner SideControl Type 8635 – 2-wire More info.	<input type="checkbox"/> Positioner SideControl Remote Type 8792 More info. <input type="checkbox"/> Process Controller SideControl Remote Type 8793 More info.
Power supply 24 VDC Communication Setpoint / feedback analogue Signal or via BUS <input type="checkbox"/> Profibus DP <input type="checkbox"/> DeviceNet <input type="checkbox"/> Positioner version Input 0/4 - 20 mA / 0-5/10 V Feedback <input type="checkbox"/> 4 - 20 mA <i>or/and</i> <input type="checkbox"/> Binary <input type="checkbox"/> PID Controller version ³⁾ Input measuring signal 4 - 20 mA / Pt100 / Frequency Inductive proximity switch <input type="checkbox"/> 1 <input type="checkbox"/> 2 Please specify item no. if known: <input type="text"/>	<input type="checkbox"/> Standard <input type="checkbox"/> ATEX/FM Zone 1 <input type="checkbox"/> Zone 2/22 Power supply 24 VDC via Setpoint or BUS Communication Setpoint / feedback analogue signal or via BUS <input type="checkbox"/> Profibus PA <input type="checkbox"/> Positioner version Input 4-20 mA Feedback <input type="checkbox"/> 4-20 mA <i>or/and</i> <input type="checkbox"/> Binary <input type="checkbox"/> PID Controller version ³⁾ Input measuring signal 4-20 mA Inductive proximity switch <input type="checkbox"/> 1 <input type="checkbox"/> 2 Please specify item no. if known: <input type="text"/>	Power supply 24 VDC Communication <input type="checkbox"/> without <input type="checkbox"/> Profibus DPV1 Feedback <input type="checkbox"/> Analogue feedback + 2 binary outputs <input type="checkbox"/> 2 binary outputs Electrical connection <input type="checkbox"/> Cable gland <input type="checkbox"/> Multipol connection Please specify item no. if known: <input type="text"/>

⁴⁾ same setpoint for input and feedback signal as for Positioner version

Comments